



# Computer Learning System

## Parent's Guide

Version 2.0

Model Number: 71657

Please keep this guide for future reference, as it contains important information.

Adult assembly is required.

Tool required for assembly: Slotted screwdriver (not included).

**Fisher-Price**

[www.fisher-price.com](http://www.fisher-price.com)

# Table of Contents

Message to Parents .....	.3
Your Computer Learning System .....	.5
Minimum System Requirements .....	.6
Installing .....	.7
Uninstalling .....	.9
Assembling the Keyboard Topper to Your Keyboard .....	.10
Removing the Keyboard Topper from Your Keyboard .....	.19
Let's Learn Together .....	.20
Beginner .....	.21
Intermediate .....	.22
Advanced .....	.23
Troubleshooting .....	.24
Customer Support .....	.24

WINDOWS® is a registered trademark of Microsoft Corporation.

MACINTOSH® is a registered trademark of Apple Computer, Inc.

## Message to Parents

Baby Smartronics™ Computer Learning System introduces your baby to the world of computers! This system includes a Grow-With-Me CD-ROM for three stages of developmental learning and a child-friendly keyboard topper to fit over your computer keyboard.

The Grow-With-Me software is specially designed to grow with your child as your child develops new play patterns, skills, interests and knowledge. With beginner (level 1), intermediate (level 2) and advanced (level 3) levels of play, your child will stay challenged. And, as you play and learn together, you'll know when it's time go to the next level or to review a previous one!

Press any button on the keyboard topper in beginner for fun surprises. In intermediate, press a button for alphabet or number recognition; telephone play and more. In advanced, images on screen prompt your child for a specific response.



## Message to Parents

Baby Smartronics™ Computer Learning System is designed to be a supervised activity. Under proper supervision, the keyboard topper and software will provide a safe and enjoyable shared experience for you and your child. Do not leave your infant or toddler unattended in a chair with access to the cords and accessories that are associated with a computer.



### **CAUTION**

Do not leave your child unattended  
when using this product.



# Your Computer Learning System

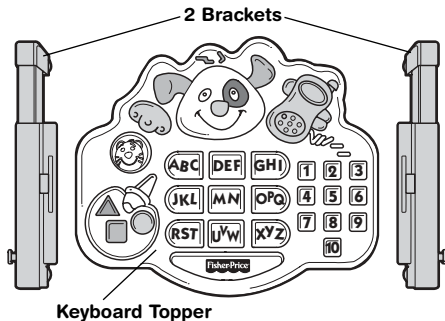

CD

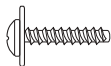

#4 x 1/2" Screws - 2  
Shown Actual Size



## CAUTION

This product contains small parts  
in its unassembled state.  
Adult assembly is required.



# Minimum System Requirements

## WINDOWS®

### Operating System:

Windows® 95, 98, Millennium, 2000 and XP.

### Minimum Requirements:

Pentium 90 or better

16 MB of memory (RAM)

SVGA Video card with 256 Colors

800x600 minimum  
screen resolution

20 MB (minimum)/50 MB  
(recommended) hard disk  
space available

Windows® Compatible Mouse

4x CD-ROM  
(Quadruple Speed CD-ROM)

DirectX 6.0 Certified sound card

Internet connection-optional



## MACINTOSH®

### Operating System:

OS 7.5.1 or higher

### Minimum Requirements:

Power Macintosh® or better

16 MB of memory (RAM)

256-color graphics

800x600 minimum  
screen resolution

20 MB (minimum)/50 MB  
(recommended) hard disk  
space available

4x CD-ROM  
(Quadruple Speed CD-ROM)

Internet connection-optional



# Installing

In order to run the program, you will first need to run the installer to setup the necessary program files on your hard drive.

## **WINDOWS®**

1. Insert the CD-ROM disc into the CD-ROM drive.
2. If you have the Auto Insert notification feature enabled for your CD-ROM, the installation will start automatically and you can skip steps 3-5. If this feature is not enabled, please follow steps 3-6.
3. Select Start and then run from the Windows® taskbar.
4. In the dialog box, type D: \ Setup ("D:" refers to your CD-ROM drive. (If your CD-ROM drive is not D: type the appropriate letter.)
5. Click the OK button.
6. Follow the installation instructions.



# Installing

## MACINTOSH®

1. Insert the CD-ROM disc into the CD-ROM drive. When the Baby Smartronics™ folder appears on your desktop, click on it.
2. When the folder opens, click on the Baby Smartronics™ icon. Follow the instructions in the install program.
3. If you have problems with installing, uninstall the program using the instructions on the next page. Then disable any preferences or extensions that are not needed for basic operation of the computer and CD-ROM drive. You can do this by using Extensions Manager (or another third-party extensions manager, such as Conflict Catcher or Startup Manager). Check your Control Panel for this utility.
4. If you do not have this type of utility, move the unnecessary extensions in a folder called "Extensions (disabled)" and the Control Panels in a folder called "Control Panels (disabled)."
5. Restart your computer and install the software again.





# Uninstalling

## WINDOWS®

1. Select Start from the Windows® taskbar and then find the Uninstall icon in the Fisher-Price® Baby Smartronics™ program group at the Start menu.
2. Click the Uninstall icon.
3. Follow the Uninstall instructions.

### **You can also uninstall the program by running the Windows® Add/Remove Programs program:**

1. Select Start from the Windows® taskbar and then find and click the Control Panel icon under Settings.
2. Double click the Add/Remove Programs icon in the Control Panel folder.
3. Select Baby Smartronics™ from the list of programs and click the "Add/Remove" button.
4. Follow the Uninstall instructions.

## MACINTOSH®

1. Open your Applications folder and drag the Baby Smartronics™ folder to the Trash.
2. Open your Preferences folder and drag the Baby Smartronics™ preferences to the Trash.
3. Empty the Trash.



# Assembling the Keyboard Topper to Your Keyboard

1

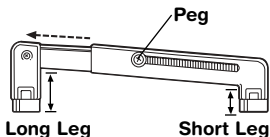
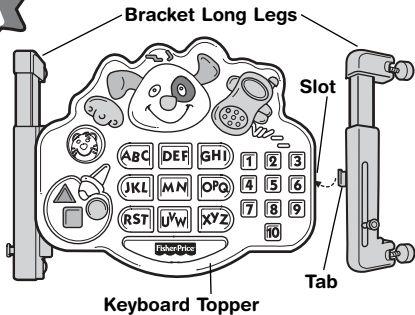

Note the long leg and short leg on each bracket.

Bracket

- Pull the peg out on each bracket and extend the bracket to its widest position.
- Position the brackets so that the long leg on each is toward the top of the keyboard topper and the peg on each is facing out.
- Position one of the brackets at a 45° angle to the keyboard topper. Insert and **“snap”** the bracket tab into the slot on the side of the keyboard topper.
- Repeat this procedure to assemble the other bracket to the keyboard topper.

## Assembling the Keyboard Topper to Your Keyboard

2

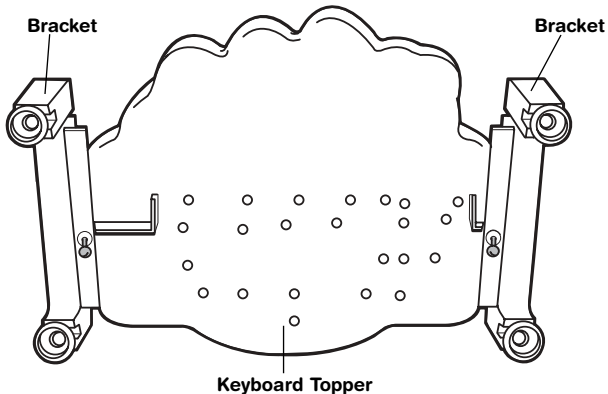

- While holding the brackets in place, carefully turn the keyboard topper over.
- Insert the screws through the brackets and into the keyboard topper. **Loosely tighten the screws with a slotted head screwdriver. Do not fully tighten the screws.**

# Assembling the Keyboard Topper to Your Keyboard

3

Small Positioning Rib

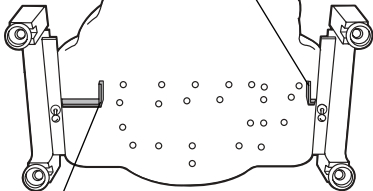

Large Positioning Rib

Keyboard Topper

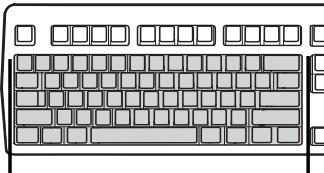

Alpha-Numeric Portion

Computer Keyboard

- Locate the positioning ribs on the underside of the keyboard topper.
- Locate the alpha-numeric portion of your computer keyboard.



# Assembling the Keyboard Topper to Your Keyboard

4

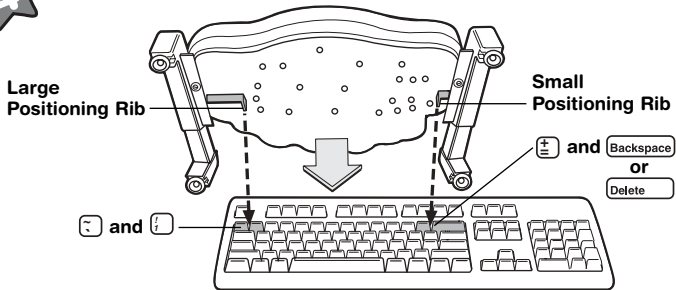

- With the keyboard topper face up, position the keyboard topper over the alpha-numeric portion of your computer keyboard.
- Fit the **small positioning rib** (vertical portion) **between** the = key and the key to its right (Backspace or Delete).
- Make sure the **large positioning rib** (vertical portion) is **between** the ~ and ! keys.

**Hint:** If you have properly positioned the keyboard topper on your computer keyboard, the keyboard topper cannot be moved from side or up or down.

## Assembling the Keyboard Topper to Your Keyboard

5

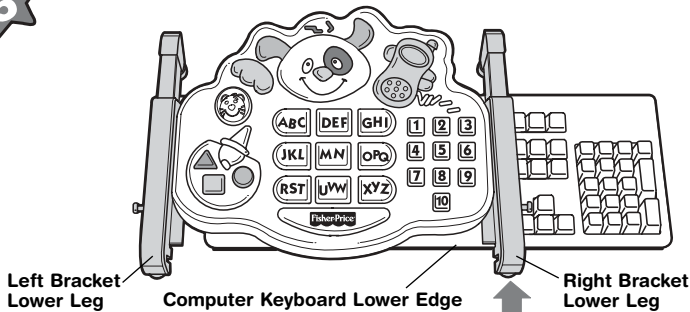

- Position the right bracket lower leg to the lower edge of the computer keyboard.

**Hint:** If you have properly positioned the keyboard topper on your computer keyboard, the left bracket lower leg will not contact the computer keyboard bottom edge.

- Position the left bracket lower leg so that it is even with the right bracket lower leg.

## Assembling the Keyboard Topper to Your Keyboard

6

Fully Tighten Screws

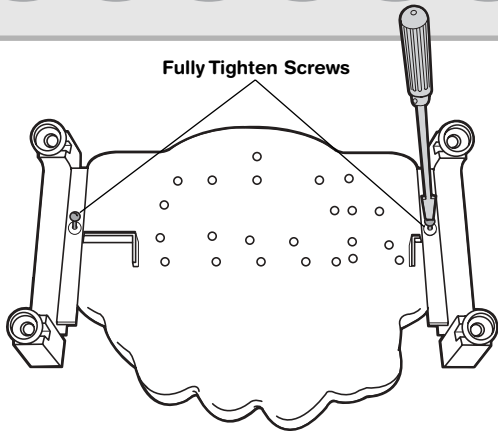

- **While keeping the brackets in position**, carefully remove the keyboard topper from your computer keyboard.
- Turn the keyboard topper over and fully tighten the screws in the brackets with a slotted screwdriver. Do not over-tighten.

# Assembling the Keyboard Topper to Your Keyboard

7

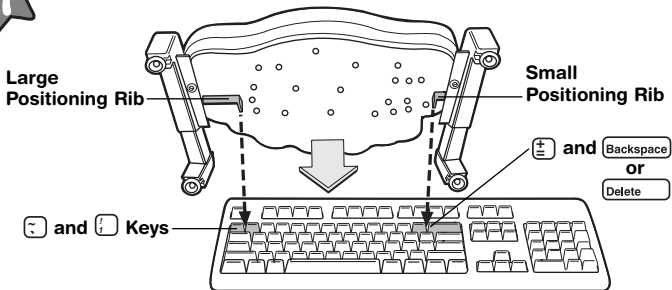

- Replace the keyboard topper over the computer keyboard. Make sure the **small positioning rib** (vertical portion) is **between** the (=) key and the key to its right (Backspace or Delete). Make sure the **large positioning rib** (vertical portion) is **between** the (~) and ([) keys.





# Assembling the Keyboard Topper to Your Keyboard

8

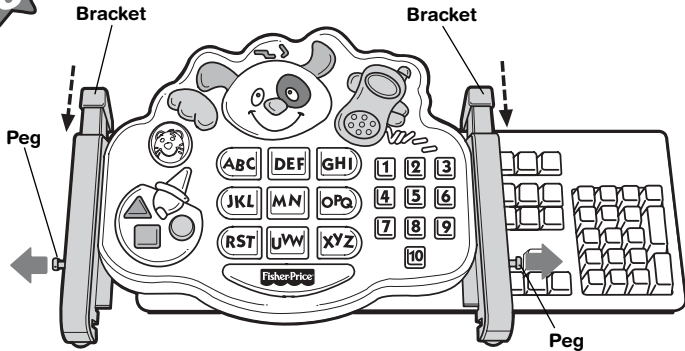

- Pull the peg out on each bracket and slide the top legs until they contact the upper edge of the computer keyboard.

# Assembling the Keyboard Topper to Your Keyboard

9

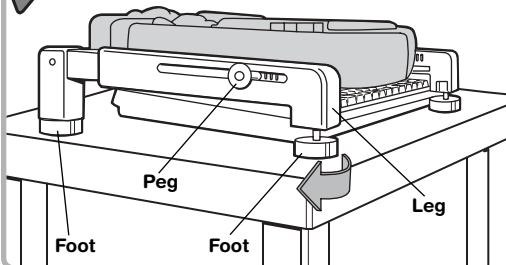

- **Adjust the height of the keyboard topper:**
  - **To insure proper function**, make sure the underside of the keyboard topper is **just above** the computer keyboard keys.
  - Make sure each foot is contacting your computer desk.
- Turn the feet on each bracket to raise or lower the keyboard topper.

Keyboard Topper is just above computer keyboard keys.

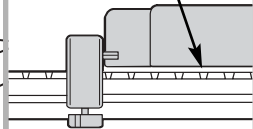

Correct

Keyboard Topper is touching computer keyboard keys.

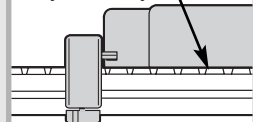

Incorrect

# Removing the Keyboard Topper from Your Keyboard

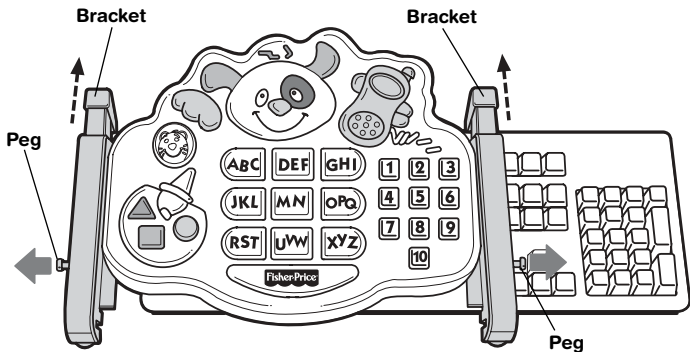

- Pull the peg out and slide it to enlarge the bracket to its widest position.
- Remove the keyboard topper from your computer keyboard.

## **IMPORTANT!**

When replacing the keyboard topper to your computer keyboard, remember to re-adjust the keyboard topper top legs. The keyboard topper top legs should contact the upper edge of your computer keyboard.

# Let's Learn Together



## Home

**Hint:** Use your computer keyboard mouse to make selections from the Home screen. Selections on the Home screen cannot be made using the keyboard topper.

**Auto Play Tips** - Click to see play tips at the top of each screen.

**Background Music** - Click for a delightful selection of children's music.

**Web Connection** - Click to automatically launch your internet software and visit our Fisher-Price® website.\*

**Parent Content Guide** - Click to read our Parent Content Guide and First Year of Learning. The Parent Content Guide includes information about the software and gives you some general guidelines on ways to use the software now and as your baby grows. Then, read the First Year of Learning, an article about how and what your baby learns. You can also browse some of our other Fisher-Price® toys.

**Level Selection** - Click the desired level of play.

**Quit** - Click to exit this program.

**Start** - Click to start play on the desired level.

\*If you do not have internet service, you will not be able to access our Fisher-Price® website.



# Beginner



## Level 1

Home



Tips



- Press any button on the keyboard topper for animated scenes, fun sounds and music.
- Using your computer keyboard mouse, click the  for tips.
- Using your computer keyboard mouse, click the  house to return to the home screen.





# Intermediate

## Level 2

Home

Tips



- Press any button on the keyboard topper for a corresponding image and sound.
- Using your computer keyboard mouse, click the  for tips.
- Using your computer keyboard mouse, click the  to return to the home screen.



# Advanced

## Level 3





**Park**



**Farm**



**House**

- Visit the park, the farm or the house! Simply press the telephone and let your child make a selection. Images prompt your child to respond with a specific touch of a button.
- Using your computer keyboard mouse, click the  for tips.
- Using your computer keyboard mouse, click the  to return to the home screen.

# Customer Support and Troubleshooting

## Troubleshooting

Please refer to the README document included in this program. It provides solutions to problems you may encounter while using this software. To access this document, simply quit out of the program. Then, enter the folder that you installed on your hard drive. Locate the README and click on it.

## Questions?

### We'd like to hear from you!

Call Fisher-Price® Consumer Relations, toll-free at **1-800-432-5437**, 8 AM - 6 PM EST Monday through Friday. Hearing-impaired consumers using TTY/TDD equipment, please call 1-800-382-7470. Or, write to: Fisher-Price® Consumer Relations, 636 Girard Avenue, East Aurora, New York 14052.



## For countries outside the United States:

### **CANADA: Questions? 1-800-567-7724.**

Mattel Canada Inc., 6155 Freemont Blvd., Mississauga, Ontario L5R 3W2.

**GREAT BRITAIN:** Mattel UK Ltd, Vanwall Business Park, Maidenhead SL6 4UB.  
Helpline: 01628 500302.

**AUSTRALIA:** Mattel Australia Pty. Ltd., 658 Church Street, Locked Bag #870, Richmond, Victoria 3121 Australia.

Consumer Advisory Service 1300 135 312.

**NEW ZEALAND:** 16-18 William Pickering Drive, Albany 1331, Auckland.

**ASIA:** Mattel East Asia Ltd, Room 1106, South Tower, World Finance Centre, Harbour City, Tsimshatsui, HK, China.



Fisher-Price, Inc., a subsidiary of Mattel, Inc., East Aurora, NY 14052 U.S.A.  
©2003 Mattel, Inc. All Rights Reserved. © and ™ designate U.S. trademarks of Mattel, Inc.

PRINTED IN CHINA

71657c-0920